

Date _____ Project _____

Notes _____

4.4 STATIC WHITE CLASSIC RIBBONLYTE

Whether you want to imitate the warm glow of candlelight, or provide a high visibility work environment similar to a bright afternoon, our Static White Classic RibbonLyte can provide a solution to fill your needs. White lighting is the primary way we illuminate our world. 4.4 Static White Classic RibbonLyte is a great option for brightening areas like coves, under-cabinets, closets, stairs, rails and much more. Indoor and outdoor rated, 4.4 RibbonLyte is suitable for residential or commercial uses.



- 4.4 W/ft (14.4 W/m)
- Create a custom fixture with our channels
- 6 white color temperatures
- 90+ CRI
- 2-Step MacAdam's ellipse binning

Applications:

Commercial Hospitality Residential
 Entertainment Museums Retail
 Healthcare Public Spaces



ORDERING GUIDE

Category	CRI	Ribbon Type & IP Rating	Wattage + Color	
RB	90			
RB - Ribbonlyte	90 - 90+ CRI White	SWCL20 - Static White Classic IP20	4.424 - 4.4 2400K	4.435 - 4.4 3500K
		SWCL65 - Static White Classic IP65	4.427 - 4.4 2700K	4.440 - 4.4 4000K
		SWCL68 - Static White Classic IP68	4.430 - 4.4 3000K	4.460 - 4.4 6000K

CONNECTION OPTIONS

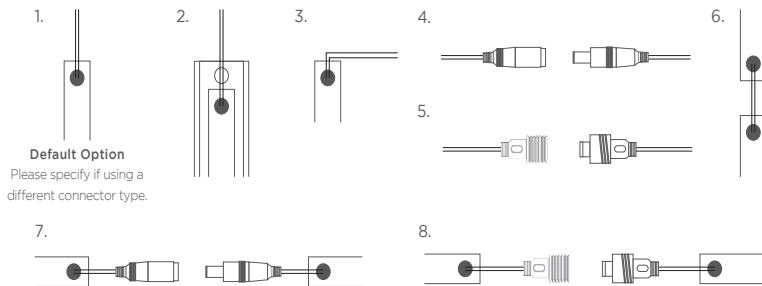





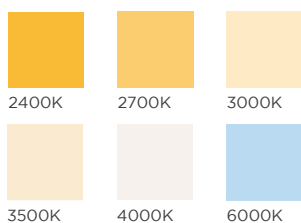

- 1 - End Feed Hard Wire Connection
- 2 - Back Feed Hard Wire Through Channel
- 3 - Side Feed Hard Wire Connection
- 4 - IP20 Connector Input
- 5 - IP67 Connector Input
- 6 - Soldered Daisy-Chain
- 7 - Daisy Chain with IP20 Connectors
- 8 - Daisy Chain with IP67 Connectors

AVAILABLE COLOR TEMPERATURES



SPECIFICATIONS / DIAGRAM / USAGE GUIDELINES

4.4 STATIC WHITE CLASSIC RIBBONLYTE						
Operating Voltage	24 V					
Power Consumption	4.4 W/ft (14.4 W/m)					
Current (mA) - 24V	183 mA/ft (600 mA/m)					
LED Pitch	18 LEDs/ft (60 LEDs/m)					
Protection Rating	IP20, IP65, IP68					
Dimming/Control	ELV / MLV / 0-10 Volt / DMX / Lutron A-Series 1% dimming LED drivers / DALI					
Operating Temperature	-40° F to 158° F (-40° C to 70° C)					
Colors Temperatures	2400K	2700K	3000K	3500K	4000K	6000K
MacAdam's Ellipses (SDCM)	2-Step Binning					
Lumens	305 lm/ft (1001 lm/m)	308 lm/ft (1010 lm/m)	359 lm/ft (1178 lm/m)	363 lm/ft (1191 lm/m)	348 lm/ft (1142 lm/m)	344 lm/ft (1129 lm/m)
Binning Tolerance	+/- 100K					
LED Beam Angle	120°					
Lamp Life	43,000 hrs L70 @ 131° F (55° C)					
Cutable Length	3.94 in (100 mm)					
CRI - All Color Temp.	90+ CRI					
Lumens/Watt	69.3 lm/W	70.0 lm/W	81.6 lm/W	82.5 lm/W	79.1 lm/W	78.2 lm/W
Constant Voltage	✓					
Cable Length	12 in (30.5 cm)					
Certifications	ETL Listed: UL 2108 Issued: 2004/02/27 Ed: 1 Rev: 2014/02/24 Low Voltage Lighting Systems CSA C22.2#9.0 Issued: 1996/06/01 Ed: 1 (R2011) General Requirements for Luminaires; with Gen. Inst. 1: 1997, Gen Inst. 2: 1998. ROHS compliant UL 2108 - Low Voltage Lighting Systems UL 8750 - Light Emitting Diode (LED) Equipment for Use in Lighting Products UL 1598 / CSA 250.0-08 - Luminaires					

24V DIMENSIONS	Top View	Side View	Dimensions
IP20	 <p>CUTTABLE EVERY: 3.94 in (100 mm)</p>		<p>Width 0.39 in (10 mm) Max Length* 25 ft 6 in (7.8 m) Height 0.09 in (2.3 mm)</p>
IP65	 <p>CUTTABLE EVERY: 3.94 in (100 mm)</p>		<p>Width 0.39 in (10 mm) Max Length* 25 ft 6 in (7.8 m) Height 0.125 in (3.2 mm)</p>
IP68	 <p>CUTTABLE EVERY: 3.94 in (100 mm)</p>		<p>Width 0.52 in (13.3 mm) Max Length* 25 ft 6 in (7.8 m) Height 0.19 in (4.8 mm)</p>

*Max length before additional power is introduced
 Maximum run length for IP68 waterproof Ribbonlyte is 25 ft 6 in (7.8 m). For Single runs longer than 25 ft 6 in (7.8 m), ribbonlyte will be daisy chained.

USAGE GUIDELINES

- When installing this product take into account the surface temperature of the material this product is mounted to. Many building surfaces which are exposed to direct sunlight exceed the 70° C / 158° F maximum that our product is rated for. High risk locations like this should be avoided.
- Our IP65 can be used in wet, outdoor locations around swimming pools and spa tubs, but our products are not intended to be submerged in pools and fountains and do not carry UL676 certification to do so.
- Please refer to our RibbonLyte Proper Use Guide in our *Application Guide* for more information. Available for download at www.GENLEDBrands.com/Home/Acolyte
- Compatible with a wide variety of control products including the entire line of Lutron dimming systems.
- For use with GENLED Acolyte[®] drivers, 0-10V dimming modules and interface controllers (DMXINF models).
- Use with non-GENLED Acolyte[®] supplied Triac, MLV or ELV drivers is not supported or warranted.
- Due to the nature of the product, RibbonLyte cuttable lengths are generally longer or shorter than the customer requested length. Unless specified, RibbonLyte is factory cut at the shorter cuttable point.
- We reserve the right to make changes to product lineup, specifications, design and finishes at any time without notice.

GENLED Acolyte[®] does not warrant or represent that the information is free from errors or omission. The information may change without notice and GENLED Acolyte[®] is not in any way liable for the accuracy of any information printed and stored or in any way interpreted or used.

CHANNEL COMPATIBILITY / CHANNEL OPTIONS

	IP20/IP65	IP68
AC1	✓	✓
AC2	✓	✓
AC3	✓	
AC4	✓	✓
AC5	✓	✓
AP1	✓	✓
AR1	✓	
AR2	✓	
AR3	✓	✓
AS1	✓	
AS2	✓	
AS3	✓	✓
AS6	✓	✓
AS20G	✓	
AT4	✓	✓
AT5	✓	✓
AT11	✓	
AW35	✓	✓
B1	✓	
C22	✓	✓
GL1	✓	
GL2	✓	✓
ROUND	✓	✓
W31	✓	✓
WH35	✓	✓

SURFACE MOUNTED CHANNELS

LENS OPTIONS: C - Clear F - Frosted M - Milky G - Grazer

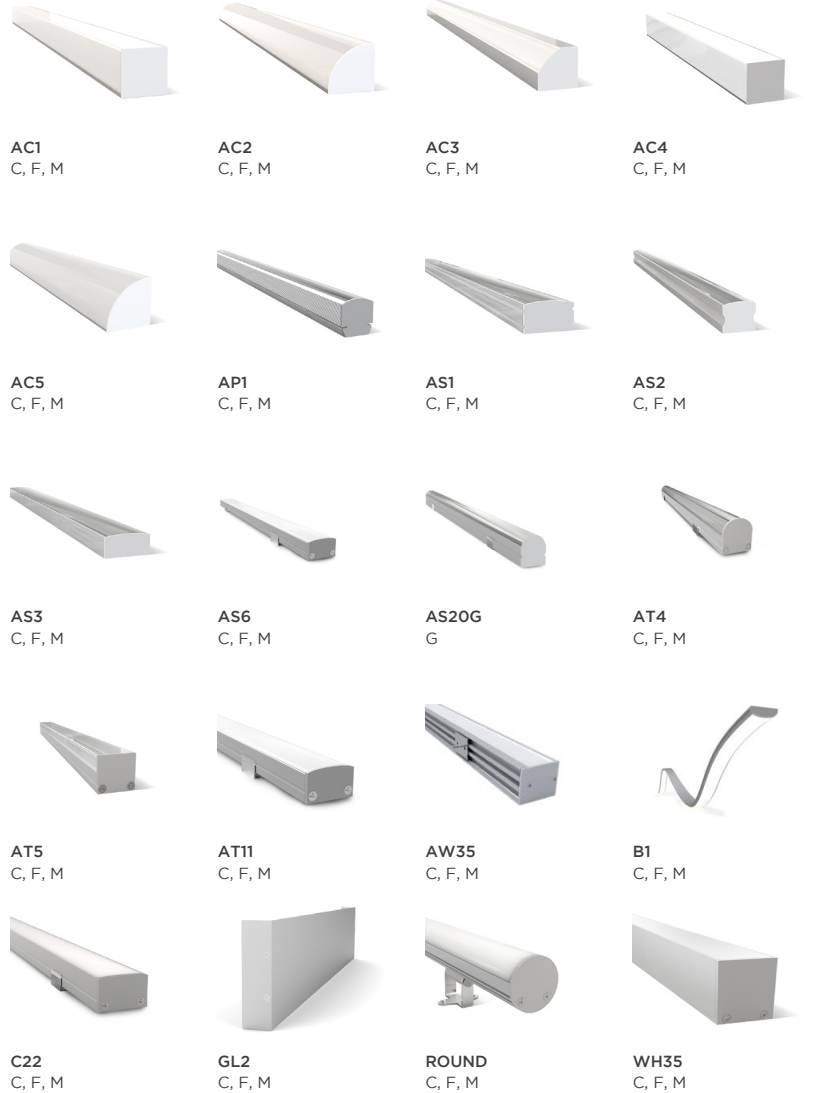

RECESSED CHANNELS

LENS OPTIONS: C - Clear F - Frosted M - Milky

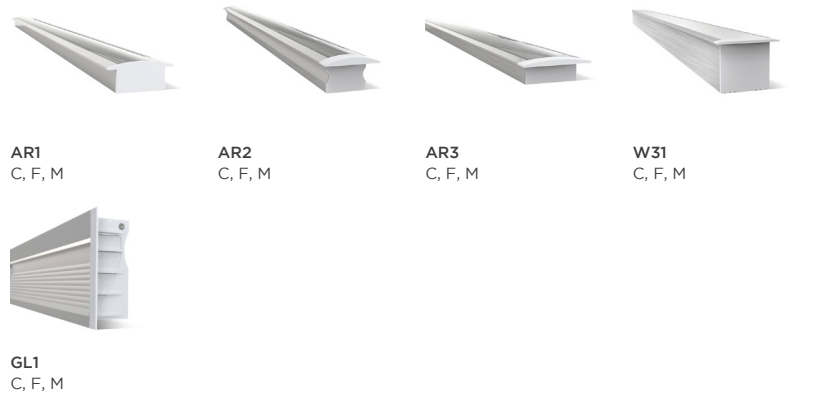

DISCLAIMER

When installing this product take into account the surface temperature of the material this product is mounted to. Many building surfaces which are exposed to direct sunlight exceed the 70°C/158°F maximum that our product is rated for. High risk locations like this should be avoided.

Our IP68 product is not intended to be submerged in pools and fountains and does not carry UL676 certification to do so.

WIRING DIAGRAMS

0-10V

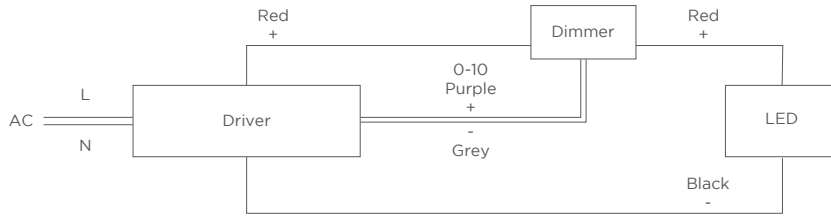

MAGNETIC + ELV

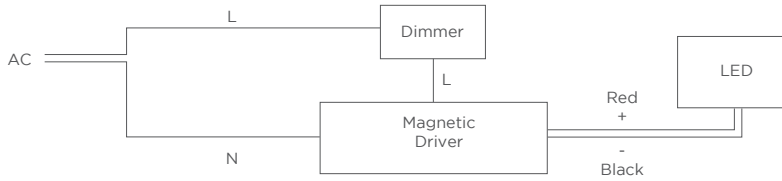

DMX

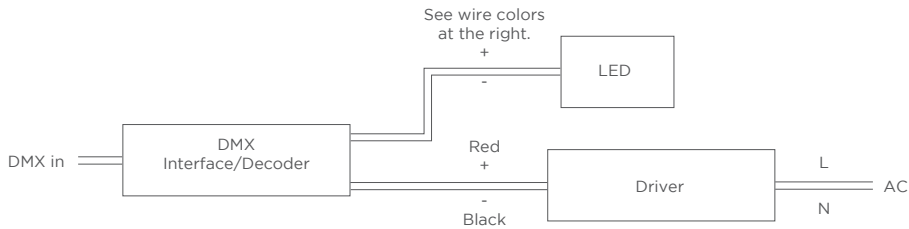

WIRE COLORS PER RIBBONLYTE COLOR

STATIC WHITE + STATIC COLOR CLASSIC

Red Wire (+) Positive

Black Wire (-) Negative